

Hi-Perform Cover

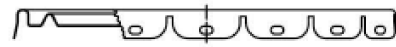

Screw Cap & Stolz Fitting:

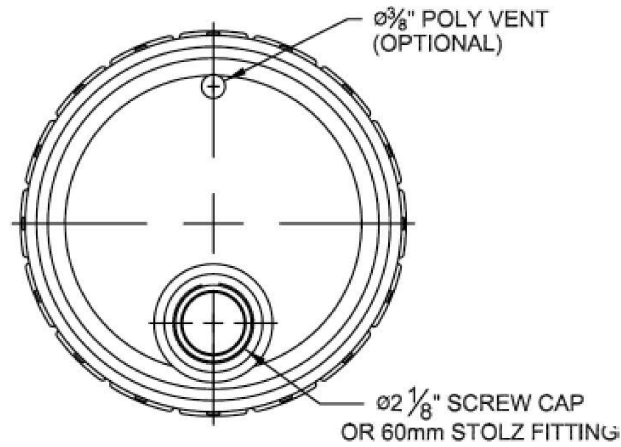
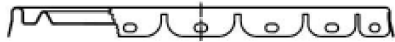
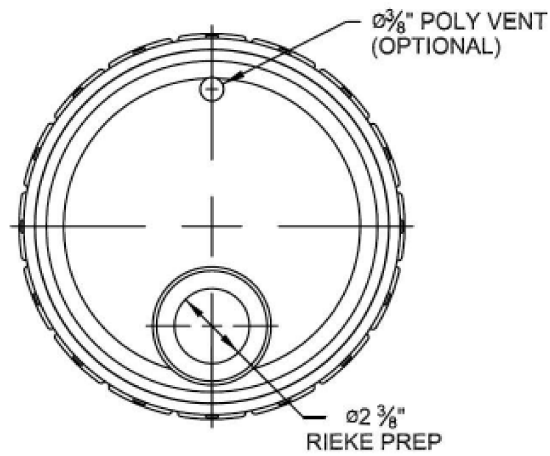

Rieke Prep:

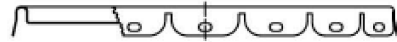
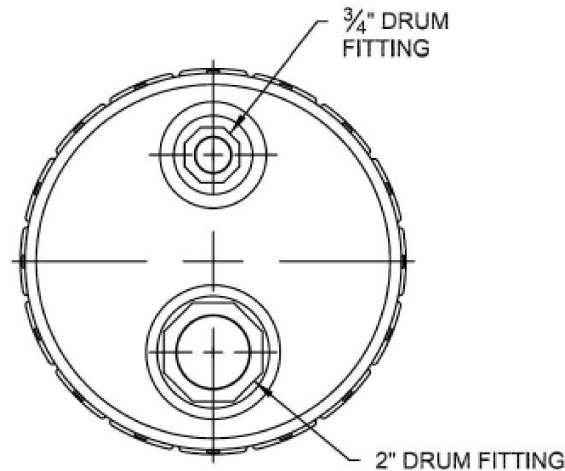

Drum Fittings:

COVER GASKETS AVAILABLE

Flow - in Gasket
G1 - EPDM Tubular Gasket
G2 - Neoprene Tubular Gasket - White
G3 - Neoprene Tubular Gasket - Black
G3Q - Neoprene Tubular Gasket
G6 - SBR Tubular Gasket - Black (small dia)

NOTES:

1. Fits all Steel pails 2.5 gallon to 7.0 gallon.

 30310 Emerald Valley Pkwy
Glenwillow, OH 44139

PPC ITEM NUMBER: 55111	SKU: 01-19-020-00267
DRAWN BY: -	CHECKED BY: -
DATE: 11/27/2018	

DESCRIPTION: 5 Gal Steel White Cover Pail	COLOR: -
PART MATERIAL: -	VOLUME: -
WEIGHT: -	
DWG NO.: -	DWG SIZE: A
SHEET NO: 1 of 1	REV: -

PROPRIETARY AND CONFIDENTIAL

THE INFORMATION CONTAINED IN THIS DRAWING IS THE SOLE PROPERTY OF PIPELINE PACKAGING. ANY REPRODUCTION IN PART OR AS A WHOLE WITHOUT THE WRITTEN PERMISSION OF PIPELINE PACKAGING IS PROHIBITED.

UNLESS OTHERWISE SPECIFIED:

UNITS OF MEASURE: Inches

TOLERANCES: Specified in drawing