

NOZZLE SIZE & TYPE	CENTER OPENING	END OPENING
RIEKE JR.		✓
32mm METRIC DIN		✓
32mm METRIC REL		✓
1 1/8" BETA		✓
1 1/4" ALPHA		✓
1 1/4" INTERNATIONAL		✓
1 3/4" ALPHA		✓
1 3/4" DELTA		✓
1 3/4" INTERNATIONAL		✓
2-5/8" SINGLE FRICTION	✓	
2-7/8" SCREW NECK	✓	

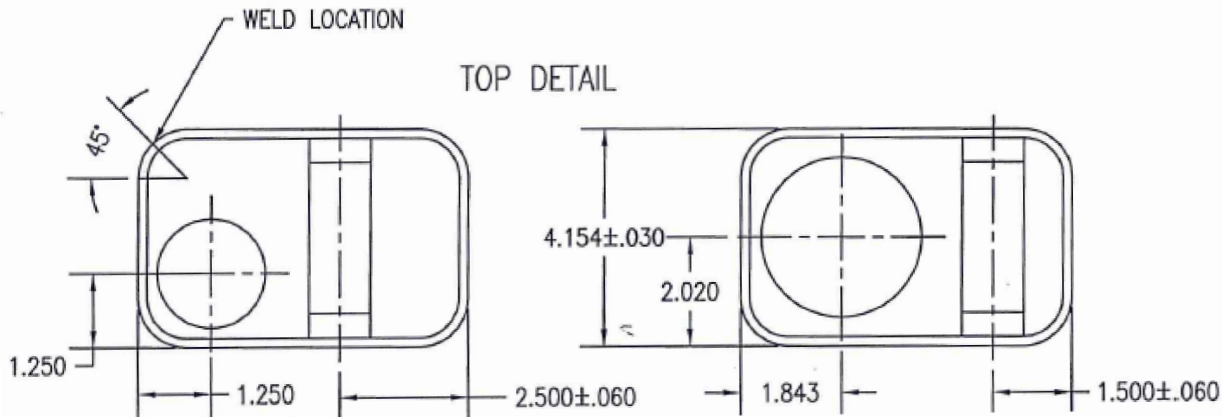

Pipeline Packaging 30310 Emerald Valley Pkwy
Glenwillow, OH 44139

PPC ITEM NUMBER: 45501 SKU: 02-21-032-00039
DRAWN BY: CHECKED BY: DATE: 11/1/2018

DESCRIPTION: 610 mm X 907 mm F-Style Can COLOR: -
PART MATERIAL: Tin VOLUME: - WEIGHT: -
DWG NO.: DWG SIZE: A SHEET NO: 1 of 1 REV: -

PROPRIETARY AND CONFIDENTIAL
THE INFORMATION CONTAINED IN THIS DRAWING IS THE SOLE PROPERTY OF PIPELINE PACKAGING. ANY REPRODUCTION IN PART OR AS A WHOLE WITHOUT THE WRITTEN PERMISSION OF PIPELINE PACKAGING IS PROHIBITED.

UNLESS OTHERWISE SPECIFIED:
UNITS OF MEASURE: Inches
TOLERANCES: Specified in drawing