

NOZZLE SIZE & TYPE	CENTER OPENING	END OPENING
RIEKE JR.	✓	
.954" INWARD CURL	✓	
.954" OUTWARD CURL	✓	
1.000" DELTA		✓
1.000" INTERNATIONAL		✓
1 1/8" BETA		✓
1 1/4" ALPHA	✓	✓
1 1/4" INTERNATIONAL		✓
1 3/4" ALPHA		✓
1 3/4" DELTA		✓
1 3/4" INTERNATIONAL		✓
32mm METRIC DIN		✓

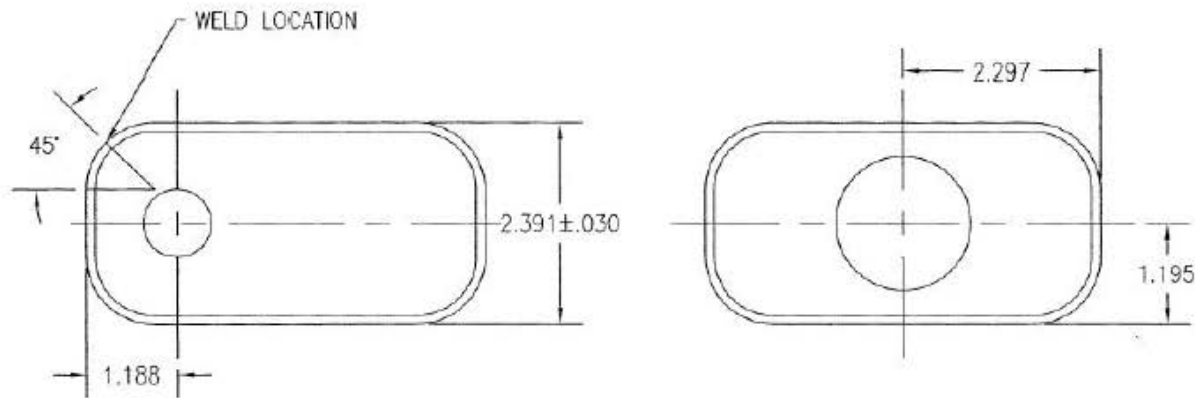
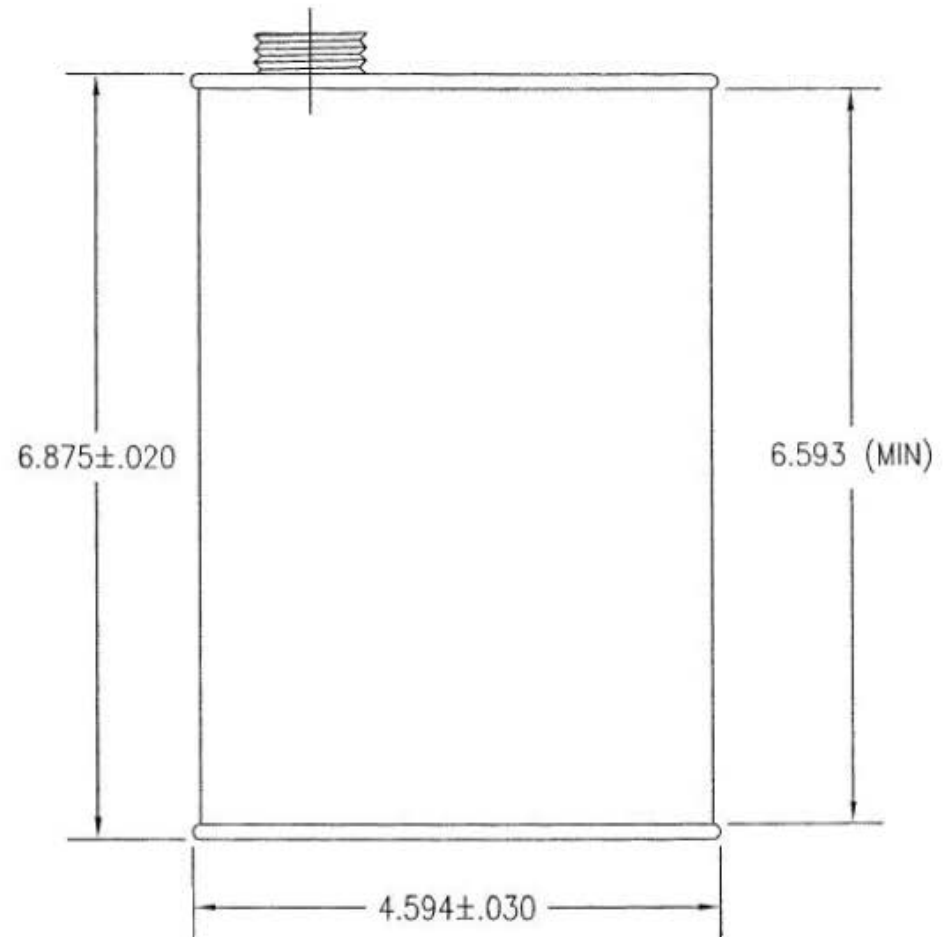

**pipeline Packaging** 30310 Emerald Valley Pkwy  
Glenwillow, OH 44139

PPC ITEM NUMBER: 46650 SKU: 02-21-032-00120  
DRAWN BY: - CHECKED BY: - DATE: 11/21/2018

DESCRIPTION: 409mm x 614mm F-Style Can COLOR: -

PART MATERIAL: - VOLUME: - WEIGHT: -

DWG NO.: - DWG SIZE: A SHEET NO: 1 of 1 REV: -

**PROPRIETARY AND CONFIDENTIAL**

THE INFORMATION CONTAINED IN THIS DRAWING IS THE SOLE PROPERTY OF PIPELINE PACKAGING. ANY REPRODUCTION IN PART OR AS A WHOLE WITHOUT THE WRITTEN PERMISSION OF PIPELINE PACKAGING IS PROHIBITED.

**UNLESS OTHERWISE SPECIFIED:**

UNITS OF MEASURE: Inches

TOLERANCES: Specified in drawing