

NOZZLE SIZE & TYPE	CENTER OPENING	END OPENING
RIEKE JR.	✓	
.954" INWARD CURL	✓	
.954" OUTWARD CURL	✓	
1.000" DELTA		✓
1.000" INTERNATIONAL		✓
1 1/8" BETA		✓
1 1/4" ALPHA	✓	✓
1 1/4" INTERNATIONAL		✓
1 3/4" ALPHA		✓
1 3/4" DELTA		✓
1 3/4" INTERNATIONAL		✓
32mm METRIC DIN		✓

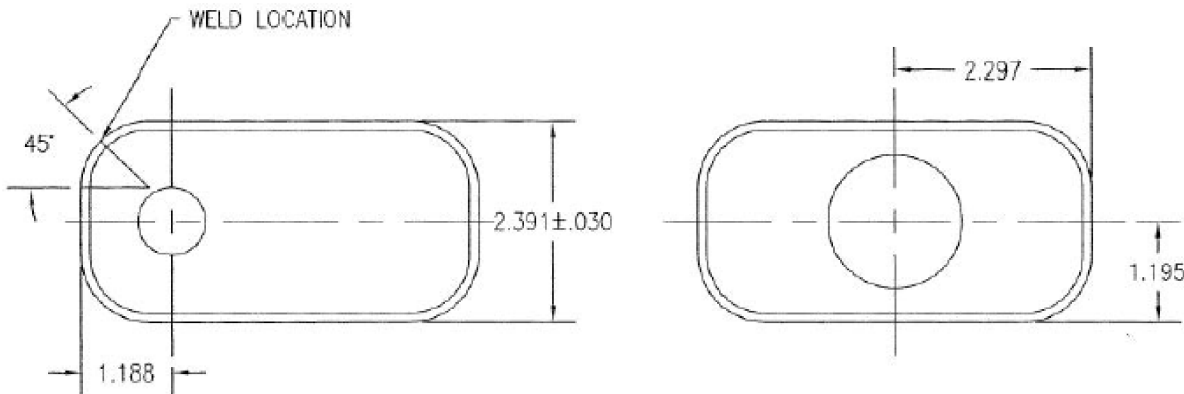
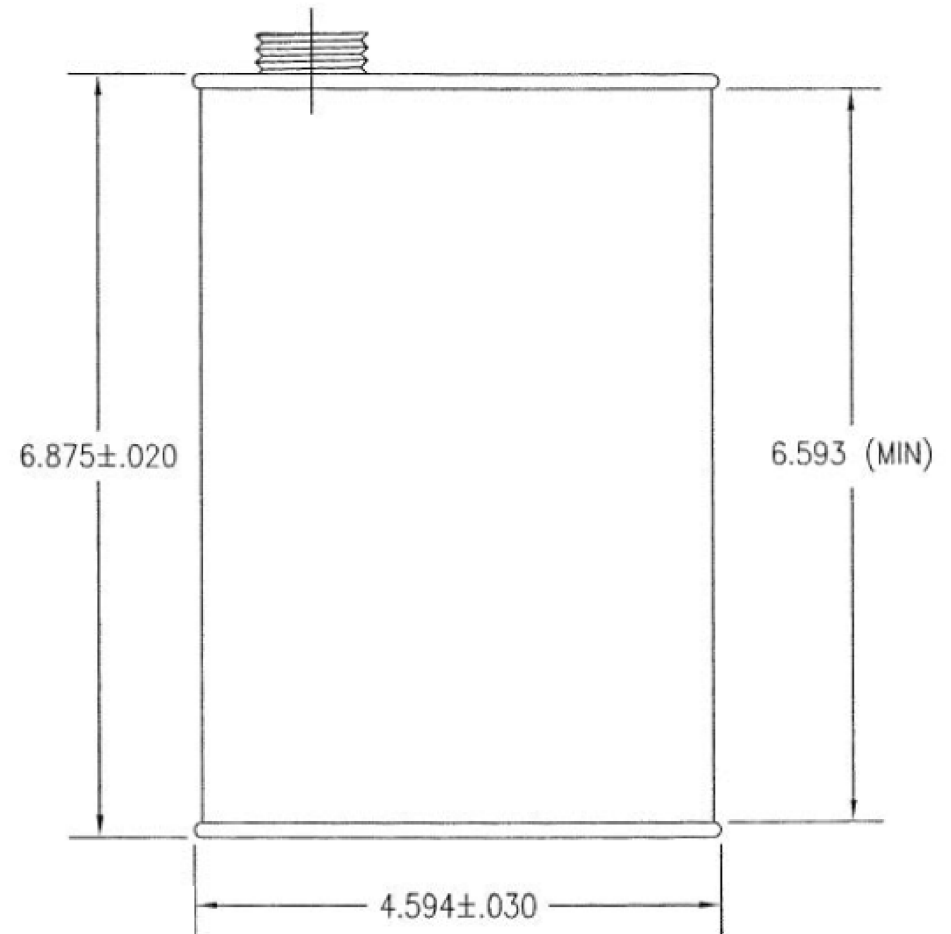

pipeline Packaging 30310 Emerald Valley Pkwy
Glenwillow, OH 44139

PPC ITEM NUMBER: 46673 SKU: 02-21-032-00125
DRAWN BY: - CHECKED BY: - DATE: 11/26/2018

DESCRIPTION: 409mm x 614mm F-Style Can COLOR: -
PART MATERIAL: - VOLUME: - WEIGHT: -
DWG NO.: - DWG SIZE: A SHEET NO: 1 of 1 REV: -

PROPRIETARY AND CONFIDENTIAL
THE INFORMATION CONTAINED IN THIS DRAWING IS THE SOLE PROPERTY OF PIPELINE PACKAGING. ANY REPRODUCTION IN PART OR AS A WHOLE WITHOUT THE WRITTEN PERMISSION OF PIPELINE PACKAGING IS PROHIBITED.

UNLESS OTHERWISE SPECIFIED:
UNITS OF MEASURE: Inches
TOLERANCES: Specified in drawing