

SECTION B-B

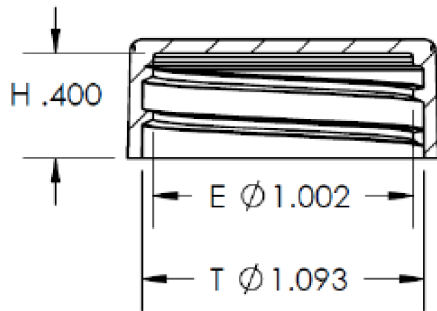

SECTION A-A

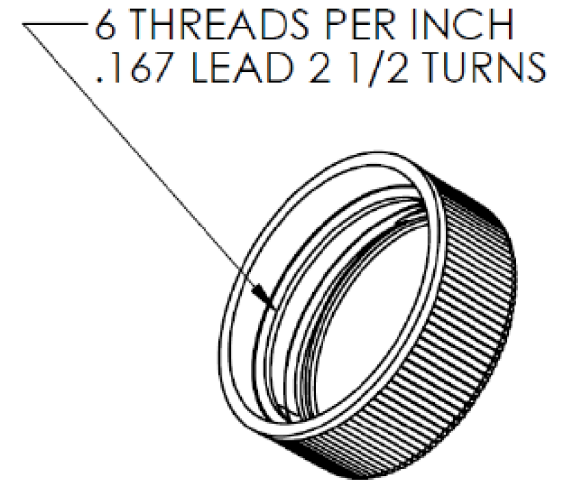

pipeline Packaging 30310 Emerald Valley Pkwy
Glenwillow, OH 44139

PPC ITEM NUMBER: 72807 SKU: 05-16-019-00189

DRAWN BY: - CHECKED BY: - DATE: 2/18/2019

DESCRIPTION: 28-400 Cont. Thread PP Closure COLOR: -

PART MATERIAL: - VOLUME: - WEIGHT: -

DWG NO.: - DWG SIZE: A SHEET NO: 1 of 1 REV: -

PROPRIETARY AND CONFIDENTIAL

THE INFORMATION CONTAINED IN THIS DRAWING IS THE SOLE PROPERTY OF PIPELINE PACKAGING. ANY REPRODUCTION IN PART OR AS A WHOLE WITHOUT THE WRITTEN PERMISSION OF PIPELINE PACKAGING IS PROHIBITED.

UNLESS OTHERWISE SPECIFIED:

UNITS OF MEASURE: Inches

TOLERANCES: Specified in drawing