

"UNCONTROLLED"

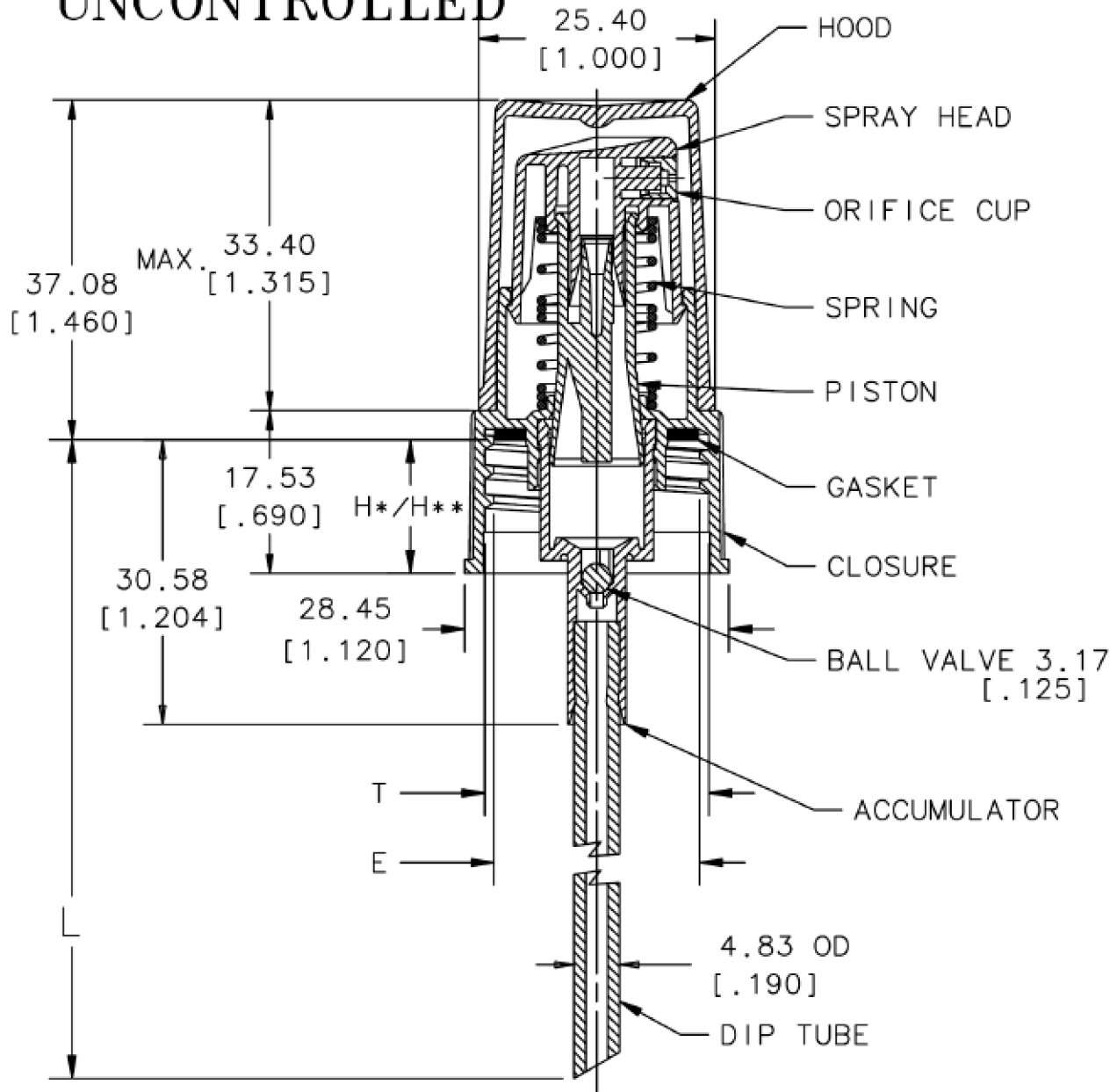

DIM	MIN	MAX
T	23.90 [.941]	24.26 [.955]
E	21.76 [.857]	22.22 [.875]
H*	15.09 [.594]	15.85 [.624]
H**	14.83 [.584]	15.59 [.614]

* TO COMPRESSED GASKET.
 ** TO UNCOMPRESSED GASKET.

NOTES:

1. DUAL DIMENSION FORMAT: MILLIMETERS[INCHES].
2. DIMENSIONS SHOWN ARE FOR REFERENCE ONLY FROM CAD DATA AND MAY NOT REFLECT CURRENT MANUFACTURING DIMENSIONS AND TOLERANCES.
3. DRAWING IS PROVIDED FOR REFERENCE ONLY AND MAY CHANGE WITHOUT NOTIFICATION.

NOMINAL OUTPUT: .70 CC



Pipeline Packaging

30310 Emerald Valley Pkwy
 Glenwillow, OH 44139

PPC ITEM NUMBER: 73226		SKU: 05-16-074-00185	
DRAWN BY: -	CHECKED BY: -	DATE: 2/19/2019	
DESCRIPTION: 24-410 Sprayer PP Closure		COLOR: -	
PART MATERIAL: -	VOLUME: -	WEIGHT: -	
DWG NO.: -	DWG SIZE: A	SHEET NO: 1 of 1	REV: -

PROPRIETARY AND CONFIDENTIAL

THE INFORMATION CONTAINED IN THIS DRAWING IS THE SOLE PROPERTY OF PIPELINE PACKAGING. ANY REPRODUCTION IN PART OR AS A WHOLE WITHOUT THE WRITTEN PERMISSION OF PIPELINE PACKAGING IS PROHIBITED.

UNLESS OTHERWISE SPECIFIED:

UNITS OF MEASURE: Inches
 TOLERANCES: Specified in drawing