

TOP
SCALE 1 : 1

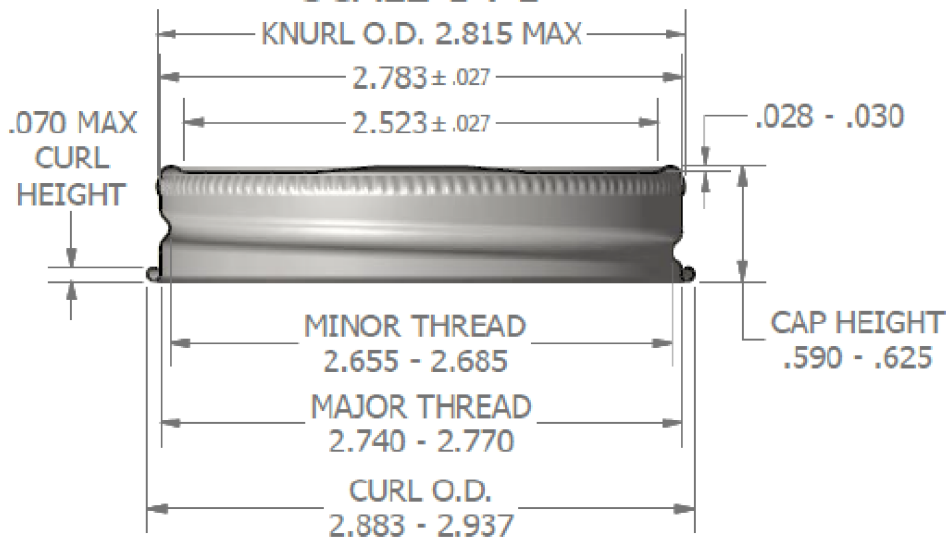

SECTION A-A
SCALE 1 : 1

NOTES:

1. THE ACTUAL MAXIMUM AND MINIMUM INSIDE DIAMETER DIMENSIONS OF THE CAP AS MEASURED WITH DEVICES OTHER THAN A PLUG GAGE.
2. THE MAX & MIN INSIDE DIAMETER OF THE THREAD ARE DETERMINED BY ROUND MAX & MIN PLUG GAGES. THE CLOSURE SHOULD PERMIT ENTRY OF THE MIN GAGE AND NO ENTRY TO ENTRY WITH A SLIGHT DRAG ON THE MAX GAGE.
3. CLOSURE DIMENSIONS SHOWN ARE THOSE WHICH HAVE BEEN FOUND TO BE FUNCTIONAL, BASED ON INDUSTRY EXPERIENCE. BECAUSE OF VARIABILITY IN CLOSURE MATERIALS AND CONTAINER DIMENSIONS, EACH CLOSURE/CONTAINER SYSTEM SHOULD BE INDIVIDUALLY EVALUATED TO ENSURE IT MEETS APPLICABLE PERFORMANCE CRITERIA.
4. CLOSURES HAVING DIMENSIONS OUTSIDE THESE RANGES ARE ALSO APPROPRIATE FOR USE IF APPLICABLE PERFORMANCE CRITERIA ARE MET. PROPER FIT OR CLOSURE TO CONTAINER IS THE CONTROLLING REQUIREMENT.
5. THE MEASUREMENT TECHNIQUES OF HOW TO MEASURE, WHAT TO MEASURE, AND WHERE TO MEASURE CLOSURES SHOULD BE AGREED UPON BY THE CUSTOMER AND TECNOCAP LLC AND BE VERIFIED BY BOTH PARTIES THROUGH A STATISTICALLY VALID RELIABILITY AND REPEATABILITY (R&R) PROCEDURE.



Pipeline Packaging

30310 Emerald Valley Pkwy
Glenwillow, OH 44139

PPC ITEM NUMBER: 70220		SKU: 05-22-019-00036	
DRAWN BY: -	CHECKED BY: -	DATE: 2/13/2019	
DESCRIPTION: 70G-450 Continuous Thread Closure		COLOR: -	
PART MATERIAL: -	VOLUME: -	WEIGHT: -	
DWG NO.: -	DWG SIZE: A	SHEET NO: 1 of 1	REV: -

PROPRIETARY AND CONFIDENTIAL

THE INFORMATION CONTAINED IN THIS DRAWING IS THE SOLE PROPERTY OF PIPELINE PACKAGING. ANY REPRODUCTION IN PART OR AS A WHOLE WITHOUT THE WRITTEN PERMISSION OF PIPELINE PACKAGING IS PROHIBITED.

UNLESS OTHERWISE SPECIFIED:

UNITS OF MEASURE: Inches

TOLERANCES: Specified in drawing