

TOP  
SCALE 2 : 1

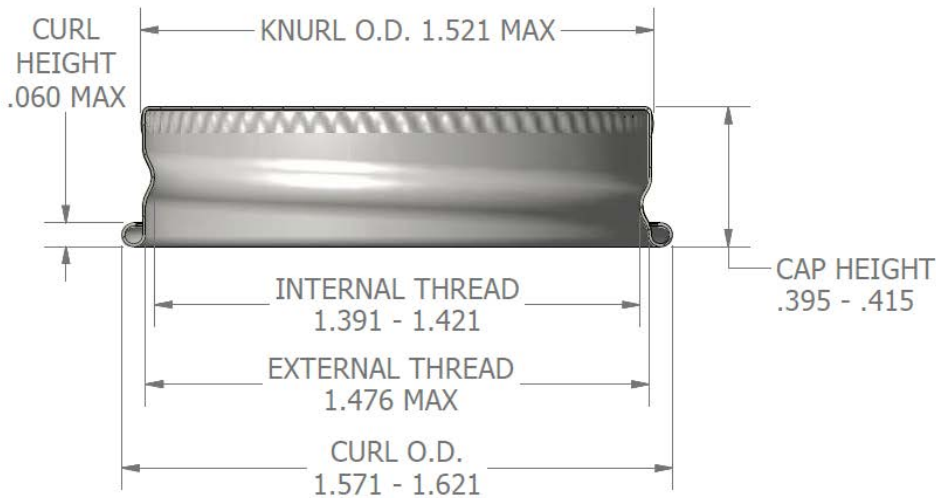

SECTION A-A  
SCALE 2 : 1

NOTES:

1. THE ACTUAL MAXIMUM AND MINIMUM INSIDE DIAMETER DIMENSIONS OF THE CAP AS MEASURED WITH DEVICES OTHER THAN A PLUG GAGE.
2. THE MAX & MIN INSIDE DIAMETER OF THE THREAD ARE DETERMINED BY ROUND MAX & MIN PLUG GAGES. THE CLOSURE SHOULD PERMIT ENTRY OF THE MIN GAGE AND NO ENTRY TO ENTRY WITH A SLIGHT DRAG ON THE MAX GAGE.
3. CLOSURE DIMENSIONS SHOWN ARE THOSE WHICH HAVE BEEN FOUND TO BE FUNCTIONAL, BASED ON INDUSTRY EXPERIENCE. BECAUSE OF VARIABILITY IN CLOSURE MATERIALS AND CONTAINER DIMENSIONS, EACH CLOSURE/CONTAINER SYSTEM SHOULD BE INDIVIDUALLY EVALUATED TO ENSURE IT MEETS APPLICABLE PERFORMANCE CRITERIA.
4. CLOSURES HAVING DIMENSIONS OUTSIDE THESE RANGES ARE ALSO APPROPRIATE FOR USE IF APPLICABLE PERFORMANCE CRITERIA ARE MET. PROPER FIT OR CLOSURE TO CONTAINER IS THE CONTROLLING REQUIREMENT.
5. THE MEASUREMENT TECHNIQUES OF HOW TO MEASURE, WHAT TO MEASURE, AND WHERE TO MEASURE CLOSURES SHOULD BE AGREED UPON BY THE CUSTOMER AND TECNOCAP LLC AND BE VERIFIED BY BOTH PARTIES THROUGH A STATISTICALLY VALID RELIABILITY AND REPEATABILITY (R&R) PROCEDURE.

**DISCLAIMER**

THIS INFORMATION IS PROVIDED AS A GENERAL GUIDE, INCLUDING DIMENSIONS. IT IS THE CUSTOMER'S RESPONSIBILITIES TO SELECT THE PROPER CONTAINER FOR PRODUCT AND APPLICATION COMPATIBILITY.

DISTRIBUTED BY:



REF NO.:

DESCRIPTION: